

# HITACHI

## SPLIT TYPE AIR CONDITIONER

ENGLISH

## INDOOR UNIT/OUTDOOR UNIT

### MODEL

RAS-X10CCK/RAC-X10CCK  
RAS-X13CCK/RAC-X13CCK  
RAS-X18CCK/RAC-X18CCK

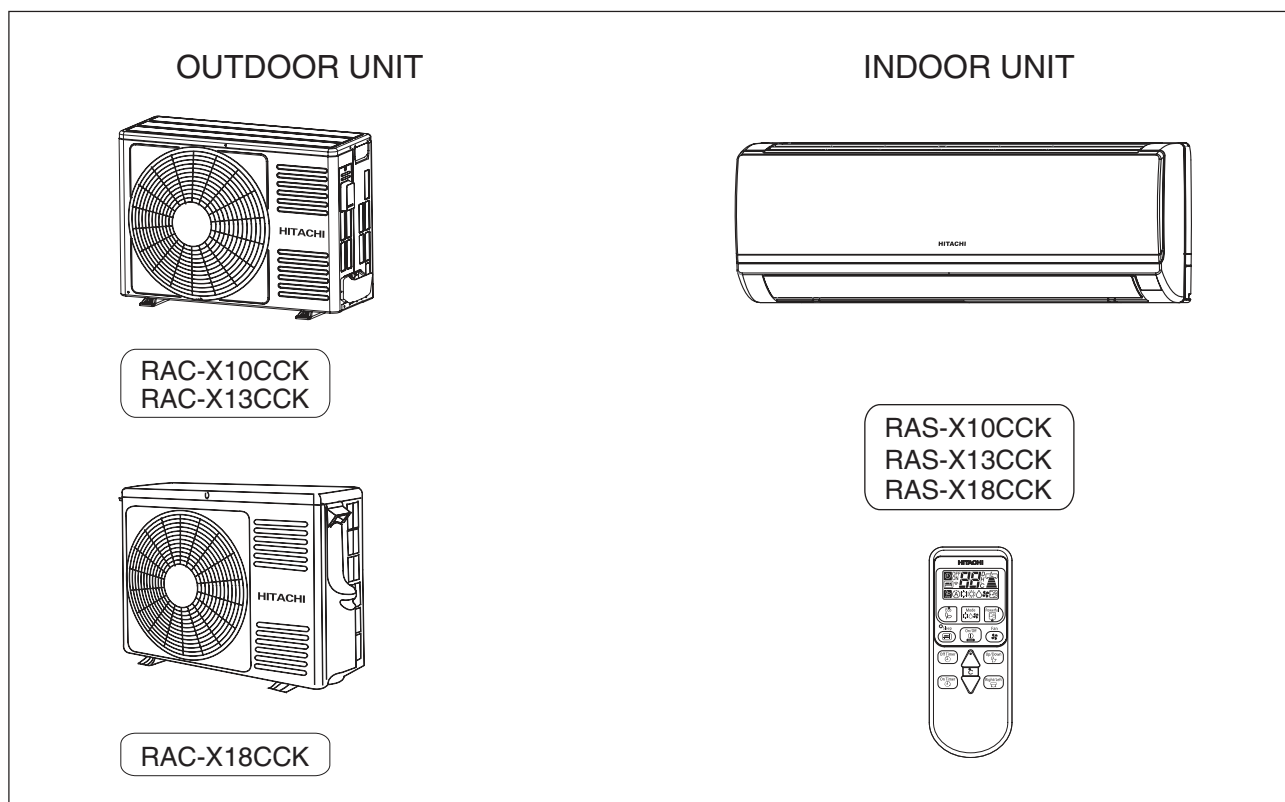

### Instruction manual

To obtain the best performance and ensure years of trouble free use, please read this instruction manual completely.

Page 1~20

### 使用說明書

請詳細閱讀這本使用說明書以了解正確的使用法，使機器長久發揮最高性能。

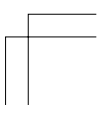
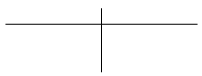
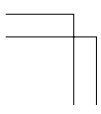
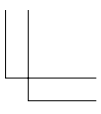
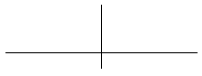
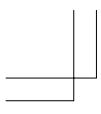

21~40頁











# SAFETY PRECAUTION





- Please read the “Safety Precaution” carefully before operating the unit to ensure correct usage of the unit.
- Pay special attention to signs of “⚠ Warning” and “⚠ Caution”. The “Warning” section contains matters which, if not observed strictly, may cause death or serious injury. The “Caution” section contains matters which may result in serious consequences if not observed properly. Please observe all instructions strictly to ensure safety.
- The signs indicate the following meanings.

 Make sure to connect earth line.	 The sign in the figure indicates prohibition.
 Indicates the instructions that must be followed.	

- Please keep this manual after reading.

PRECAUTIONS DURING INSTALLATION	
 <b>WARNING</b>	<ul style="list-style-type: none"> <li>• Do not reconstruct the unit. Water leakage, fault, short circuit or fire may occur if you reconstruct the unit by yourself. </li> <li>• Please ask your sales agent or qualified technician for the installation of your unit. Water leakage, short circuit or fire may occur if you install the unit by yourself.</li> </ul>
	<ul style="list-style-type: none"> <li>• Please use earth line. Do not place the earth line near water or gas pipes, lightning-conductor, or the earth line of telephone. Improper installation of earth line may cause electric shock. </li> </ul>
 <b>CAUTION</b>	<ul style="list-style-type: none"> <li>• A circuit breaker should be installed depending on the mounting site of the unit. Without a circuit breaker, the danger of electric shock exists.</li> </ul>
	<ul style="list-style-type: none"> <li>• Do not install near location where there is flammable gas. The outdoor unit may catch fire if flammable gas leaks around it. </li> </ul>
	<ul style="list-style-type: none"> <li>• Please ensure smooth flow of water when installing the drain hose.</li> </ul>

PRECAUTIONS DURING SHIFTING OR MAINTENANCE	
 <b>W A R N I N G</b>	<ul style="list-style-type: none"> <li>• Should abnormal situation arises (like burning smell), please stop operating the unit and turn off the circuit breaker. Contact your agent. Fault, short circuit or fire may occur if you continue to operate the unit under abnormal situation. </li> </ul>
	<ul style="list-style-type: none"> <li>• Please contact your agent for maintenance. Improper self maintenance may cause electric shock and fire.</li> </ul>
	<ul style="list-style-type: none"> <li>• Please contact your agent if you need to remove and reinstall the unit. Electric shock or fire may occur if you remove and reinstall the unit yourself improperly.</li> </ul>
	<ul style="list-style-type: none"> <li>• If the supply cord is damaged, it must be replaced by the special cord obtainable at authorized service/parts centers.</li> </ul>

PRECAUTIONS DURING OPERATION	
 <b>W A R N I N G</b>	<ul style="list-style-type: none"> <li>• Avoid an extended period of direct air flow for your health. </li> </ul>
	<ul style="list-style-type: none"> <li>• Do not put objects like thin rods into the panel of blower and suction side because the high-speed fan inside may cause danger. </li> </ul>
	<ul style="list-style-type: none"> <li>• Do not use any conductor as fuse wire, this could cause fatal accident. </li> </ul>
	<ul style="list-style-type: none"> <li>• During thunder storm, disconnect and turn off the circuit breaker. </li> </ul>

## PRECAUTIONS DURING OPERATION

- The product shall be operated under the manufacturer specification and not for any other intended use.



- Do not attempt to operate the unit with wet hands, this could cause fatal accident.

- When operating the unit with burning equipments, regularly ventilate the room to avoid oxygen insufficiency.



- Do not direct the cool air coming out from the air-conditioner panel to face household heating apparatus as this may affect the working of apparatus such as the electric kettle, oven etc.

- Please ensure that outdoor mounting frame is always stable, firm and without defect. If not, the outdoor unit may collapse and cause danger.



- Do not splash or direct water to the body of the unit when cleaning it as this may cause short circuit.

- Do not use any aerosol or hair sprays near the indoor unit. This chemical can adhere on heat exchanger fin and blocked the evaporation water flow to drain pan. The water will drop on tangential fan and cause water splashing out from indoor unit.

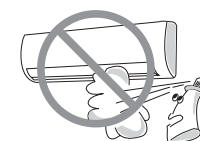

W  
A  
R  
N  
I  
N  
G

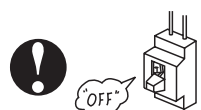

- Please switch off the unit and turn off the circuit breaker during cleaning, the high-speed fan inside the unit may cause danger.

- Turn off the circuit breaker if the unit is not to be operated for a long period.



- Do not climb on the outdoor unit or put objects on it.

- Do not put water container (like vase) on the indoor unit to avoid water dripping into the unit. Dripping water will damage the insulator inside the unit and causes short-circuit.



- Do not place plants directly under the air flow as it is bad for the plants.

- When operating the unit with the door and windows opened, (the room humidity is always above 80%) and with the air deflector facing down or moving automatically for a long period of time, water will condense on the air deflector and drips down occasionally. This will wet your furniture. Therefore, do not operate under such condition for a long time.
- If the amount of heat in the room is above the cooling or heating capability of the unit (for example: more people entering the room, using heating equipments and etc.), the preset room temperature cannot be achieved.

- This appliance is not intended for use by young children or infirm persons unless they have been adequately supervised by a responsible person to ensure that they can use this appliance safely.
- Young children should be supervised to ensure that they do not play with the appliance.

## NAMES AND FUNCTIONS OF EACH PART

### INDOOR UNIT

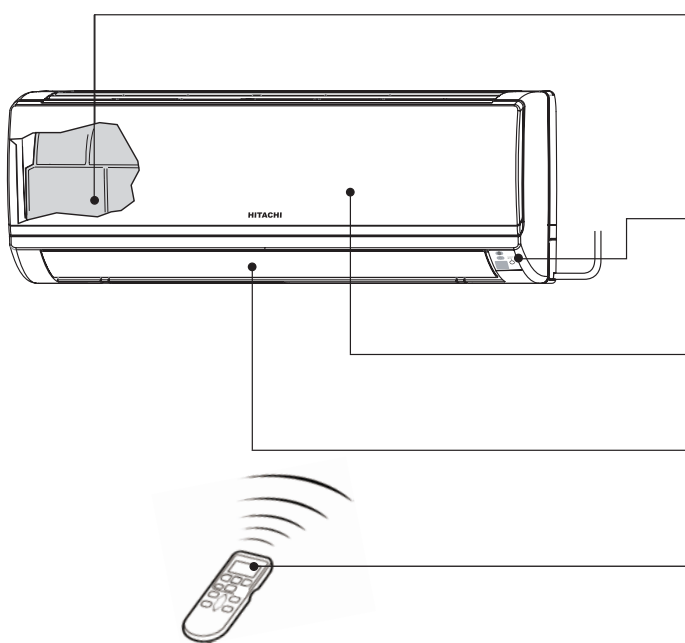

**AIR FILTER**

To prevent dust from coming into the door unit.  
(Refer page 17)

**INDOOR UNIT INDICATORS**

Light indicator showing the operating condition.  
(Refer page 6)

**FRONT PANEL** (Refer page 6)

**HORIZONTAL DEFLECTOR • VERTICAL DEFLECTOR (AIR OUTLET)**

(Refer page 14)

**REMOTE CONTROL**

Send out operation signal to the indoor unit. So as to operate the whole unit.  
(Refer page 7)

### OUTDOOR UNIT

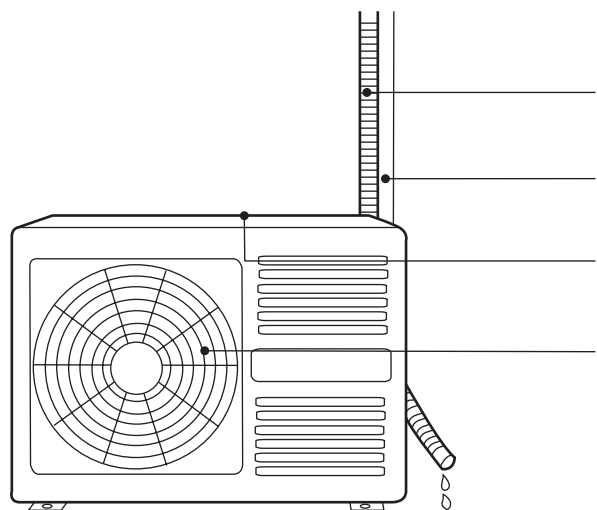

**DRAIN PIPE**

Condensed water drain to outside.

**CONNECTING CORD**

**AIR INLET (BACK, LEFT SIDE)**

**AIR OUTLET**

### MODEL NAME AND DIMENSIONS

MODEL	WIDTH(mm)	HEIGHT(mm)	DEPTH(mm)
RAS-X10CCK, RAS-X13CCK、 RAS-X18CCK	780	280	218
RAC-X10CCK、 RAC-X13CCK	700(+59)	505	258(+48)
RAC-X18CCK	750(+91)	548	288(+47)

## ATTACHING AND REMOVING FRONT PANEL

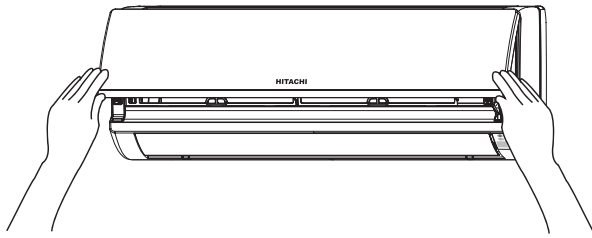

- While gripping both the left and right hand edges [recessed in the front housing] of the front panel, lift up to open the front panel.
- After completion of job, slightly lift up the front panel and pull down to close the front panel. Ensure that the 3 sets of left, centre and right clips are fully secured.

## RECEIVABLE INDICATOR FUNCTIONS

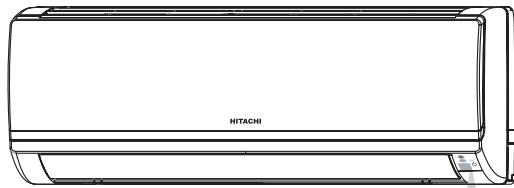

**TIMER LAMP (Orange)**  
This lamp lights when the timer is working.

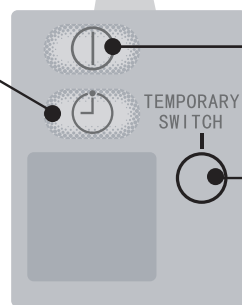

**OPERATION LAMP (Yellow)**  
This lamp lights during operation.

**TEMPORARY SWITCH**

### **⚠ CAUTION**

Turn off the circuit breaker or pull out the power plug if the unit is not be operated for a long period.

## OPERATION INDICATOR

### **TEMPORARY SWITCH**

When the remote control device is not functioning, use the Temporary Switch mode

- (1) When the Temporary Switch is pressed, the unit will operate as per the previous setting.  
When the operation is done using the temporary switch after the power source is turned off and turn on again, the operation is done in automatic mode.
- (2) Press the Temporary Switch a second time will stop the operations of the air conditioner unit.

### **AUTO RESTART FUNCTION**

In the event of power failure, the air conditioner will restart automatically.

In the event of power failure during TIMER operation, the timer will be reset and the unit will begin or stop operating under a new timer setting.

## NAMES AND FUNCTIONS OF EACH PART

### REMOTE CONTROLLER

- This controls the operation of the indoor unit.  
The range of control is about 7 meters. If indoor lighting is controlled electronically, the range of control may be shorter, in some cases, the control signal may not be received.  
This unit can be fixed on a wall using the fixture provided. Before fixing it, make sure the indoor unit can be controlled from the remote controller.
- Handle the remote controller with care.  
Dropping it or getting it wet may compromise its signal transmission capability.

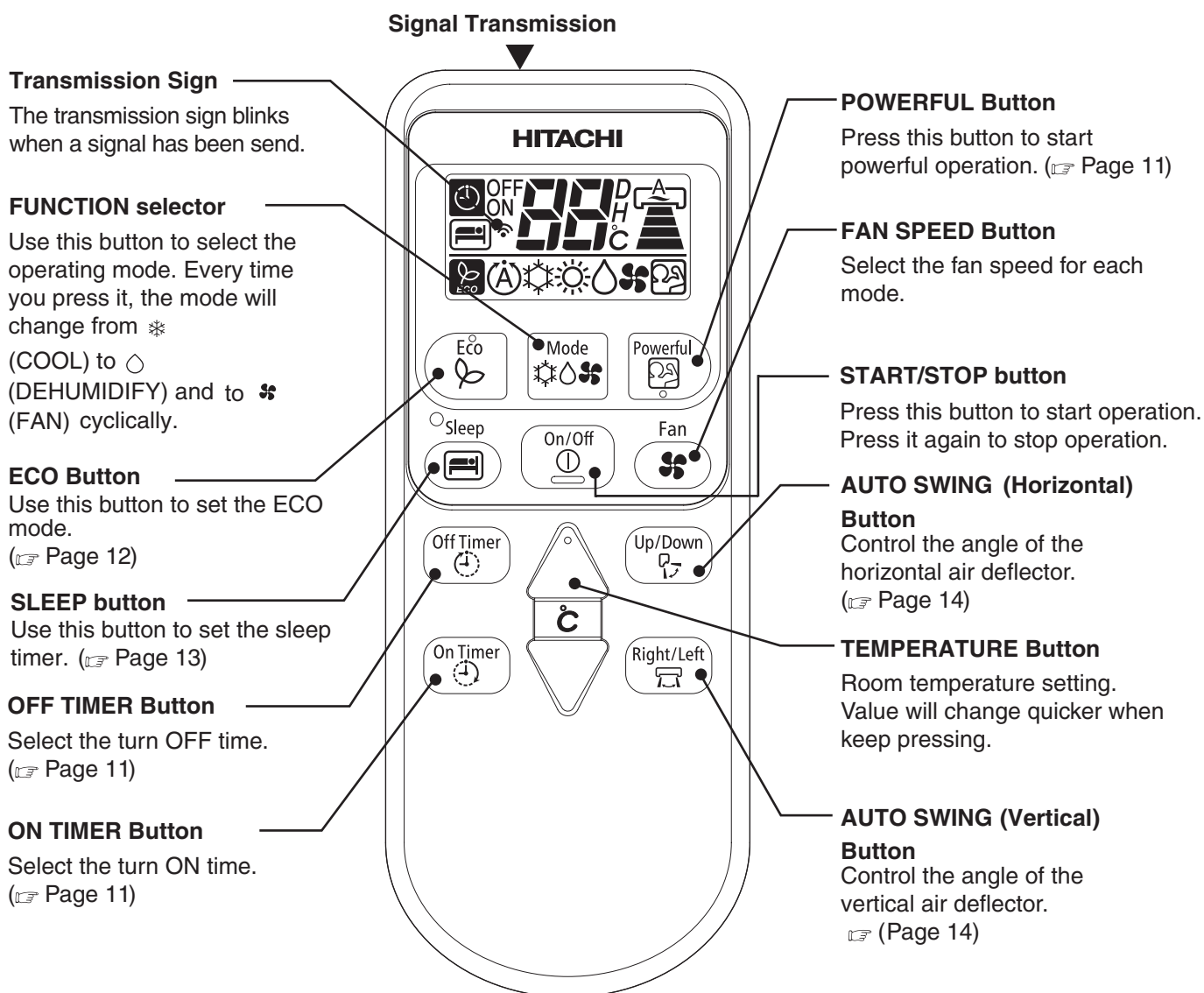

### Precautions for Use

- Do not put the remote controller in the following places.
  - In direct sunlight
  - In the vicinity of a heater.
- Handle the remote controller carefully. Do not drop it on the floor, and protect it from water.
- Once the outdoor unit stops, it will not restart for about 3 minutes (unless you turn the power switch off and on or unplug the power cord and plug it in again).  
This is to protect the device and does not indicate a failure.
- If you press the FUNCTION selector button during operation, the device may stop for about 3 minutes for protection.

# COOLING OPERATION

Use the device for cooling when the outdoor temperature is -10 to 43°C.  
 If humidity is very high (over 80%) indoors, some dew may form on the air outlet grille of the indoor unit.

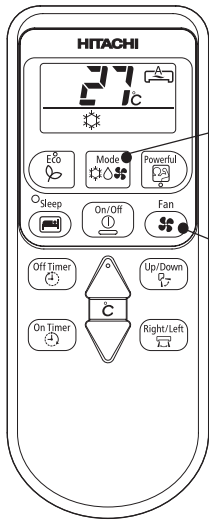

**1** Press the FUNCTION selector so that the display indicates ❄️ (COOL).

Set the desired FAN SPEED with the 🌀 (FAN SPEED) button (the display indicates the setting).

🌀 (AUTO) : The FAN SPEED is HI at first and varies to MED automatically when the preset temperature has been reached.

🌀 (HI) : Economical as the room will become cool quickly.

🌀 (MED) : Quiet.

🌀 (LOW) : More quiet.

🌀 (SILENT): Silent.

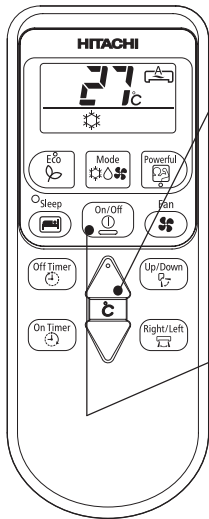

**3** Set the desired room temperature with the TEMPERATURE buttons (the display indicates the setting).

The temperature setting and the actual room temperature may vary somewhat depending on conditions.

Press the ⏻ (START/STOP) button. Cooling operation starts with a beep. Press the button again to stop operation. The cooling function does not start if the temperature setting is higher than the current room temperature (even though the ⏻ (OPERATION) lamp lights).

The cooling function will start as soon as you set the temperature below the current room temperature.

■ As the settings are stored in memory in the remote controller, you only have to press the ⏻ (START/STOP) button next time.



## DEHUMIDIFYING OPERATION

Use the device for dehumidifying when the room temperature is over 16°C.  
When it is under 15°C, the dehumidifying function will not work.

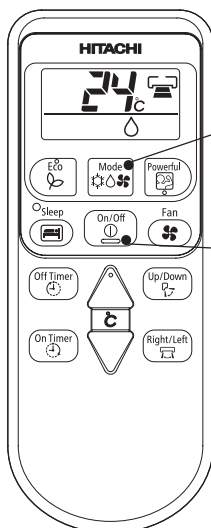

1

Press the FUNCTION selector so that the display indicates  
◊ (DEHUMIDIFY).  
Press the  (FAN SPEED) button to select LOW and SILENT.

START  
STOP

Press the  (START/STOP) button.

- When you want to change the operation mode, please use the FUNCTION selector.
- Set the desired temperature is available.

### ■ Dehumidifying Function

- Dehumidifying takes place with a target temperature which is slightly lower than the room temperature setting.  
If the room temperature becomes lower than the target value, operation stops. If the room temperature becomes higher than the target value, operation restarts.

# FAN OPERATION

You can use the device simply as an air circulator. Use this function to dry the interior of the indoor unit at the end of summer.

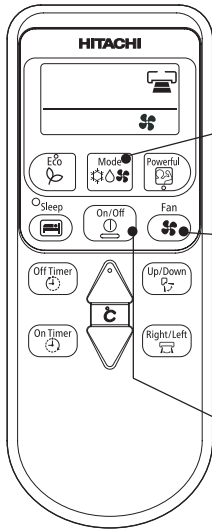

**1** Press the FUNCTION selector so that the display indicates (FAN).

**2** Press the (FAN SPEED) button.

- (HI) : The strongest air blow.
- (MED) : Quiet.
- (LOW) : More quiet.
- (SILENT): Silent.

**START STOP** Press the (START/STOP) button. Fan operation starts with a beep. Press the button again to stop operation.

## FAN SPEED (AUTO) ... When the AUTO fan speed mode is set in the cooling operation:

For the cooling operation	<ul style="list-style-type: none"> <li>• Operation starts in the “HI” mode to reach the preset temperature.</li> <li>• As room temperature approaches the preset temperature, fan speed automatically switches to “LOW”.</li> </ul>
---------------------------	---

## TIMER RESERVATION

■ ON Timer and OFF Timer are available.

■ Operation stop at setting time

### Timer Reservation

#### 1 OFF TIME setting

- Select the OFF TIME by pressing the  (OFF) Button.
- Setting time will change according to the below sequence when you press the button.

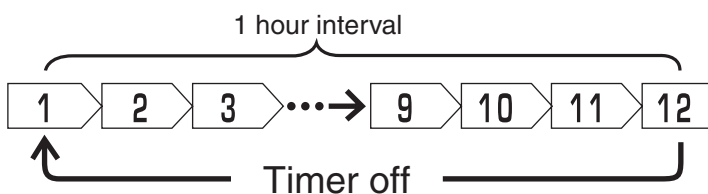

#### 2 ON TIME setting

- Select the ON TIME by pressing the  (ON) Button.
- Setting time will change according to the below sequence when you press the button.

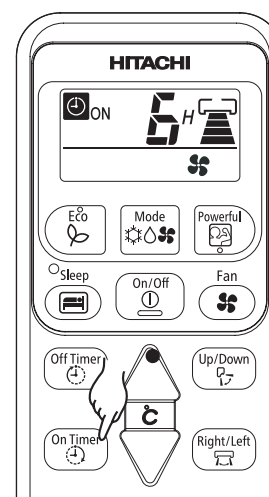
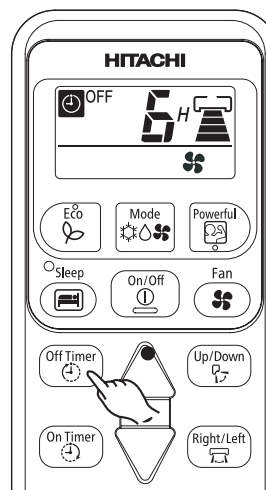
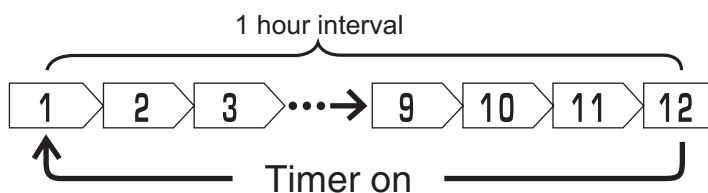



## POWERFUL OPERATION

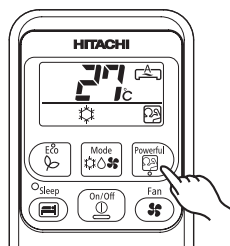

- By pressing  (POWERFUL) button during DEHUMIDIFYING, COOLING, FAN, operation, the air conditioner performs at maximum power.
- During POWERFUL operation, cooler air will be blown out from indoor unit for COOLING or operation respectively.



### START

- Press the  (POWERFUL) button during operation.
- "  " is displayed on the LCD.

### CANCEL

- Press the  (START/ STOP) button. or
- Press the  (POWERFUL) button again.
- "  " disappears from the LCD.

### NOTE

- When ECO mode is selected, POWERFUL operation is cancelled.
- During POWERFUL operation, capacity of the air conditioner will not increase –if the air conditioner is already running at maximum capacity.
- After auto restart, POWERFUL operation is cancelled and previous operation shall start.

## ECO OPERATION

- Energy saving operation by changing set temperature and by limiting the maximum power consumption value.

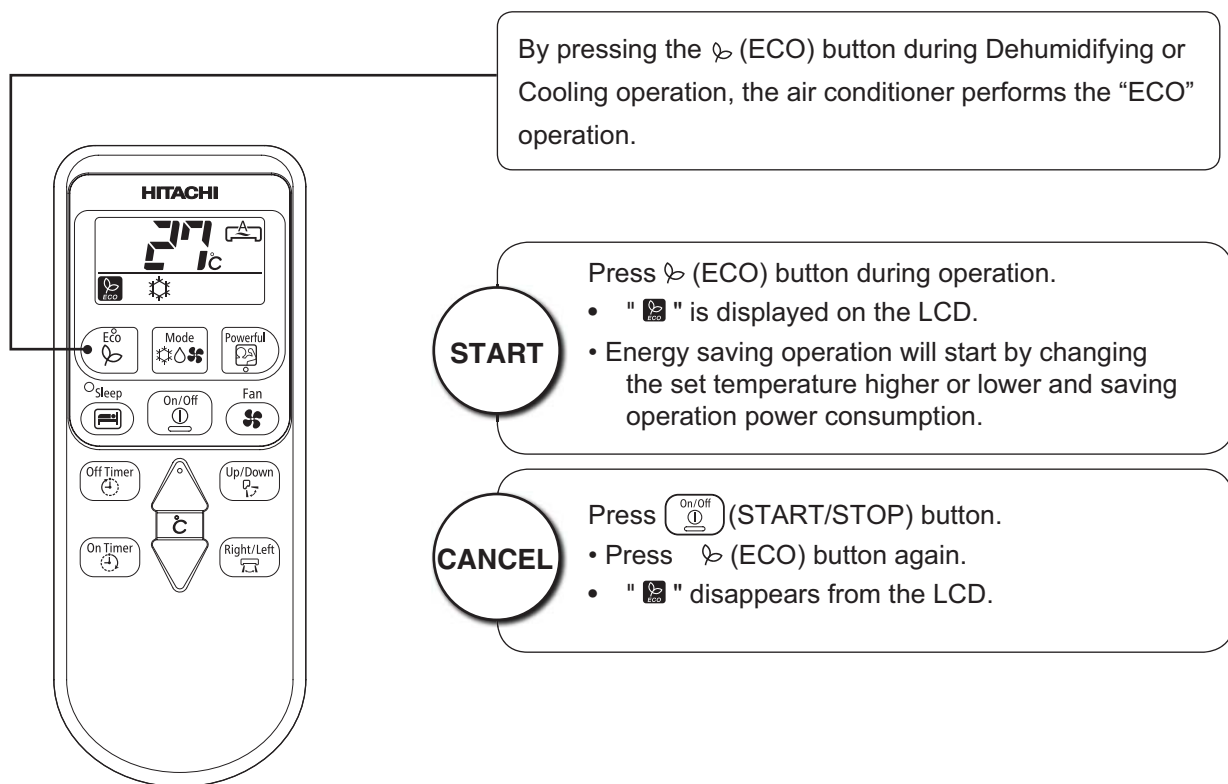

### NOTE

- In case the power consumption is already low, ECO operation will not reduce the power consumption.
- By pressing (POWERFUL) button, ECO operation is cancelled.
- After auto restart, ECO operation is cancelled and previous operation mode shall start.

## HOW TO SET THE SLEEP TIMER

By pressing  (SLEEP) button during DEHUMIDIFYING, COOLING or FAN operation, the unit shifts the room temperature and reduces the fan speed.

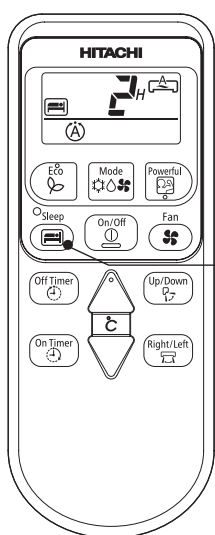

● SLEEP

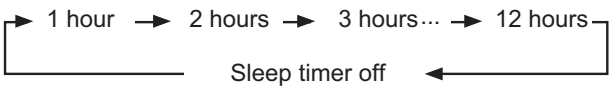

Mode	Indication
Sleep Timer	

Sleep Timer: The device will continue working for the desired number of hours and then turn off.  
 Point the signal window of the remote controller toward the indoor unit, and press the SLEEP button.  
 The timer information will be displayed on the remote controller. The TIMER lamp lights with a beep from the indoor unit.

To cancel SLEEP TIMER operation.

Press  (START/STOP) button.

- Room air conditioner will switch off.

Press  (SLEEP) button again until off time, “” and number of hour disappear from the remote controller display.

- A beep sound emitted from indoor unit and the (TIMER) lamp on the indoor unit turns off.
- SLEEP TIMER operation is cancelled.

### NOTE

If you set the sleep timer when the off-time or on-timer has been set earlier, the sleep timer becomes effective instead of the off - or on/off-timer set earlier.

## ADJUSTING THE AIR DEFLECTORS

- 1** Adjustment of the conditioned air in the upward and downward directions.

The horizontal air deflector is automatically set to the proper angle suitable for each operation. The deflector can be swung up and down continuously and also set to the desired angle using the “ (AUTO SWING(HORIZONTAL ))” button.

- If the “ (AUTO SWING(HORIZONTAL ))” button is pressed once, the horizontal air deflector swings up and down. If the button is pressed again, the deflector stops in its current position.
- Use the horizontal air deflector within the adjusting range shown in the right.
- When the operation is stopped, the horizontal air deflector moves and stops at the position where the air outlet closes.

### ⚠ CAUTION

- In “Cooling” operation, do not keep the horizontal air deflector swinging for a long time. Some dew may form on the horizontal air deflector and dew may drop.

- 2** Adjustment of the conditioned air to the left and right.

- If the “ (AUTO SWING(VERTICAL ))” button is pressed once, the deflectors will start to swing right and left. If the button is pressed again, the deflector will stop in the current position.

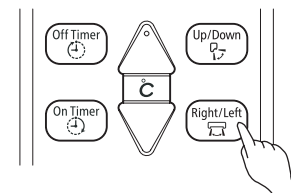
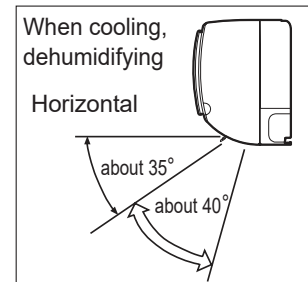
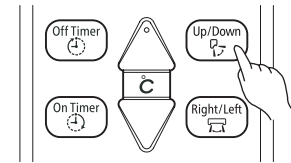

## HOW TO EXCHANGE THE BATTERIES IN THE REMOTE CONTROLLER

- 1** Remove the cover as shown in the figure and take out the old batteries.



- 2** Install the new batteries.  
The direction of the batteries should match the marks in the case.

### ⚠ CAUTION

1. Do not use new and old batteries, or different kinds of batteries together.
2. Take out the batteries when you do not use the remote controller for 2 or 3 months.

Push and pull to the direction of arrow

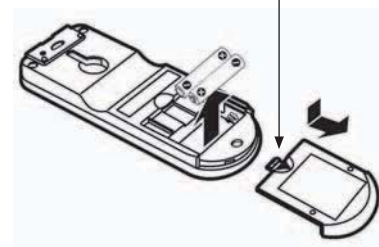



## THE IDEAL WAYS OF OPERATION

### Suitable Room Temperature



#### Warning

Freezing temperature is bad for health and a waste of electric power.

### Install curtain or blinds

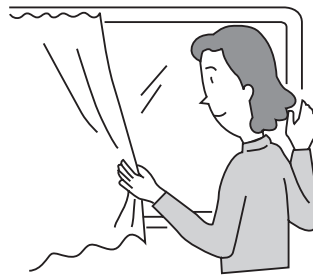

It is possible to reduce heat entering the room through windows.

### Ventilation

#### Caution

Do not close the room for a long period of time. Occasionally open the door and windows to allow the entrance of fresh air.



### Effective Usage Of Timer

At night, please use the “sleep timer operation mode”, together with your wake up time in the morning. This will enable you to enjoy a comfortable room temperature. Please use the timer effectively.

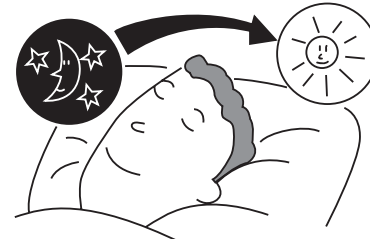

### Do Not Forget To Clean The Air Filter

Dusty air filter will reduce the air volume and the cooling efficiency. To prevent from wasting electric energy, please clean the filter every 2 weeks.

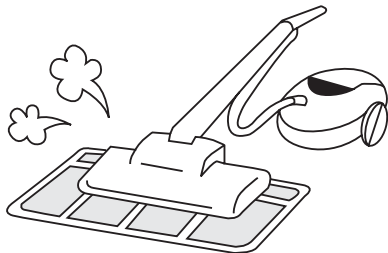

### Please Adjust Suitable Temperature For Baby And Children

Please pay attention to the room temperature and air flow direction when operating the unit for baby, children and old folks who have difficulty in movement. (The ideal temperature difference between outdoor and indoor is about  $\pm 5^{\circ}\text{C}$ ).

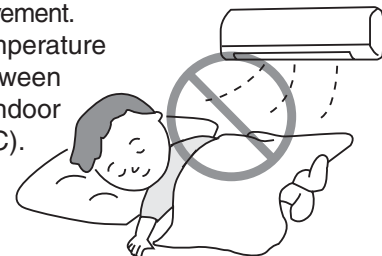



## FOR USER'S INFORMATION

### The Air Conditioner And The Heat Source In The Room

#### Caution

If the amount of heat in the room is above the cooling capability of the air conditioner (for example: more people entering the room, using heating equipments and etc.), the preset room temperature cannot be achieved.

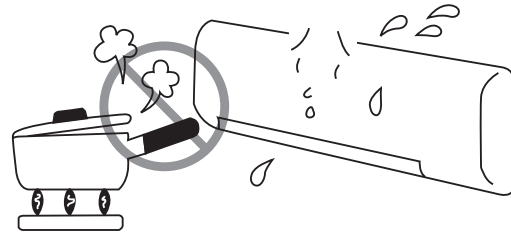

### Not Operating For A Long Time

When the indoor unit is not to be used for a long period of time, please pull out the power plug. Or the indoor unit still consumes about 1W in the operation control circuit even if it is in "OFF" mode.

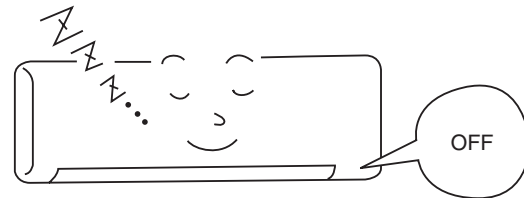

### When Lightning Occurs

#### Warning

To protect the whole unit during lightning, please stop operating the unit and remove the plug from the socket.

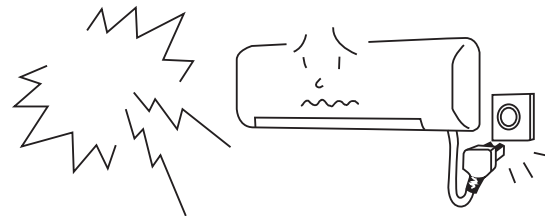

### Interference From Electrical Products

#### Caution

To avoid noise interference, please place the indoor unit and its remote controller at least 1m away from electrical products.

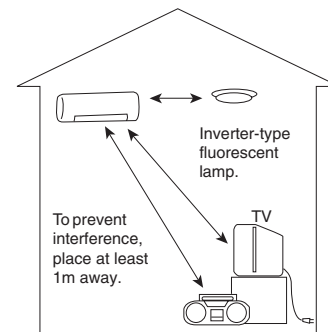



# MAINTENANCE OF THE UNITS



## CAUTION

Ensure that the unit is not in operation and all power supply has been disconnected before cleaning the units.

### Dust Filter Screen

Dust filter screens are installed to remove the indoor dust particles hence they should be kept clean at all times. They should be cleaned at each machine operation cycle of approximately 100 hours. Excessive dust collected at the dust filter screen will block the air flow, reduce the cooling capability and could produce noise. Therefore the dust filter screen should be cleaned as per instructions given below:

#### Cleaning Instructions

##### (1) Removing the dust filter screen

- While holding both edges of the front panel, open up and lift the front panel and push in to park at the secured position

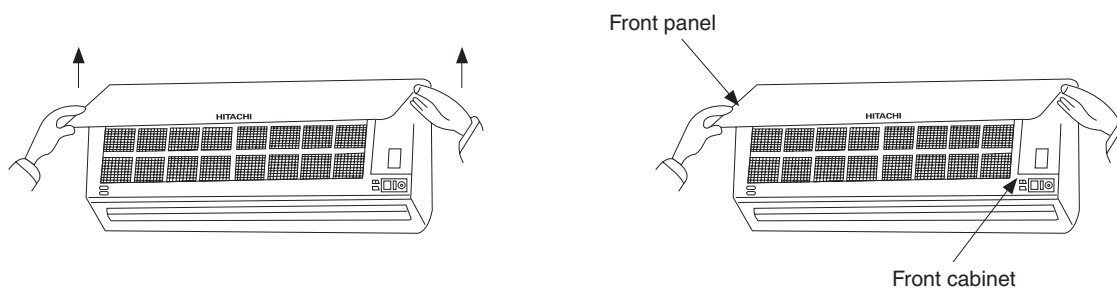

- Slightly lift up the dust filter screen, release the latch clips [2 places] located at the bottom of the front cabinet and move the dust filter screen downwards to remove it from the unit
- (2) Use a vacuum cleaner to vacuum clean the dust accumulated at the dust filter screen. If the accumulated dust is too much to be removed by vacuum cleaning, apply mild detergent and flush the dust from the dust filter screen with water. After thorough rinsing, leave the dust filter screen at a cool shaded place to dry.
- (3) Re-install the dust filter screen to its original position (With "FRONT" marker facing front). Slightly lift up the opened front panel and close it by returning it to its original position
- (4) Each year before using the air conditioner unit, clean the heat exchanger (evaporator) with a fine soft brush or a vacuum cleaner and take care to avoid damaging the evaporator fins

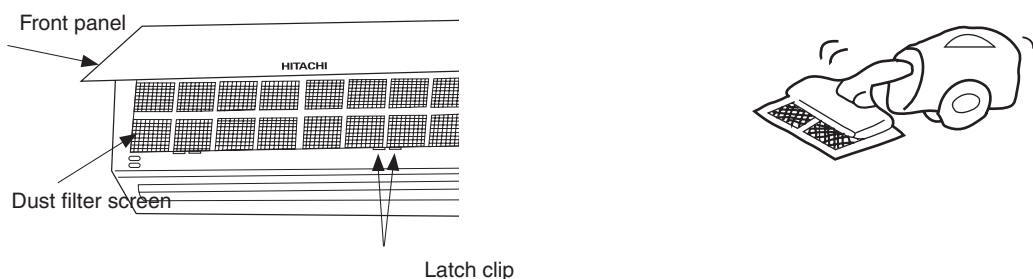

## CAUTION

- Do not use hot water (40° C and above) to rinse the dust filter screen, otherwise the screen will warp and get distorted. After rinsing, shake the dust filter screen to rid off all remaining water droplets and place it at a cool shaded place to dry. Avoid placing the dust filter screen under direct sunlight, otherwise the screen will warp and get distorted.

Do not operate the air conditioner unit without the dust filter screen installed, otherwise the ingress of dust into the air conditioner unit will cause breakdowns.

## CLEANING THE FRONT PANEL

1. Front panel can easily get dirty. Use a soft cloth to wipe it.
2. If the front panel is excessively dirty, wipe the front panel with a soft cloth either wet with warm water or containing a mild detergent after which, wipe dry the front panel with a soft dry cloth.
3. Do not use hot water (50°C and above), volatile liquid, gasoline, acid, diluting agents or brushes to clean the front panel as they could damage the plastic finishing and paintwork of the front panel.

 **CAUTION**  
Please disconnect the power plug before cleaning the front panel.

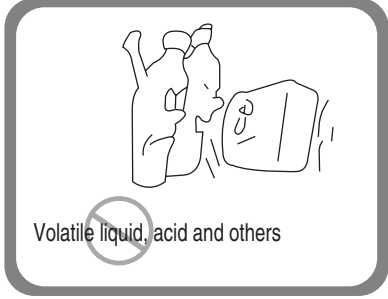
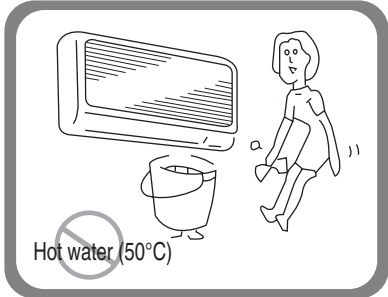

## TROUBLE SHOOTING THE UNIT BEFORE CONTACTING SERVICE STAFF TO CHECK AND RECTIFY

The air conditioner unit is not operating.

- Check whether the power supply plug is properly plugged in.

Abnormal air conditioning effects.

1. Is the dust filter screen clogged with dust and dirt?
2. Is the outdoor unit is located in direct sunlight?
3. Is there any blockage to the air flow of both the indoor and outdoor units?
4. Are the doors and windows being left opened or is there any heat source inside the room?
5. Is the temperature setting appropriate?

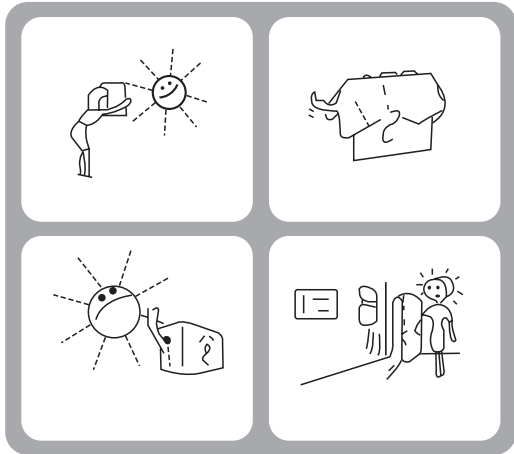



## AFTER SALE SERVICE AND WARRANTY

### WHEN ASKING FOR SERVICE, CHECK THE FOLLOWING POINTS.

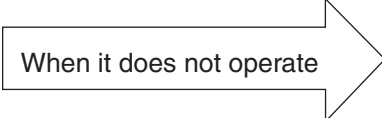
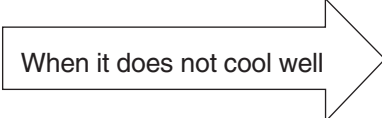
CONDITION	CHECK THE FOLLOWING POINTS
 <p>When it does not operate</p>	<ul style="list-style-type: none"> <li>• Is the fuse all right?</li> <li>• Is the voltage extremely high or low?</li> <li>• Is the circuit breaker "ON"?</li> </ul>
 <p>When it does not cool well</p>	<ul style="list-style-type: none"> <li>• Is the air filter blocked with dust?</li> <li>• Does sunlight fall directly on the outdoor unit?</li> <li>• Is the air flow of the outdoor unit obstructed?</li> <li>• Are the doors or windows opened, or is there any source of heat in the room?</li> <li>• Is the set temperature suitable?</li> </ul>



#### Notes

- In quiet or stop operation, the following phenomena may occasionally occur, but they are not abnormal for the operation.
  - (1) Slight flowing noise of refrigerant in the refrigerating cycle.
  - (2) Slight rubbing noise from the fan casing which is cooled and then gradually warmed as operation stops.
- The odor will possibly be emitted from the room air conditioner because the various odor, emitted by smoke, foodstuffs, cosmetics and so on, sticks to it. So please clean the air filter and the evaporator regularly to reduce the odor.

- Please contact your sales agent immediately if the air conditioner still fails to operate normally after the above inspections. Inform your agent of the model of your unit, production number, date of installation. Please also inform him regarding the fault.
- Power supply shall be connected at the rated voltage, otherwise the unit will be broken or could not reach the specified capacity.



# HITACHI

## 分離式冷氣機

### 室內機/室外機

中國語

型式

**RAS-X10CCK/RAC-X10CCK**  
**RAS-X13CCK/RAC-X13CCK**  
**RAS-X18CCK/RAC-X18CCK**

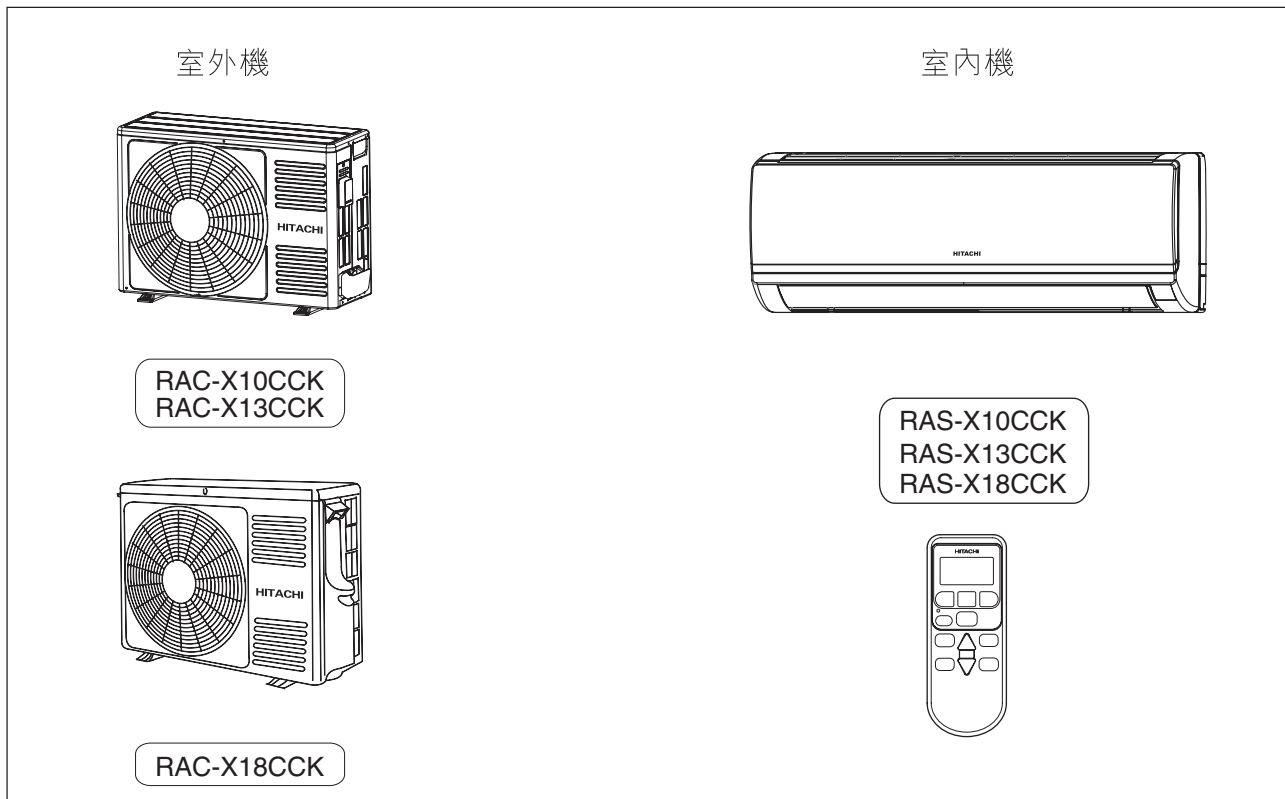

#### Instruction manual

To obtain the best performance and ensure years of trouble free use, please read this instruction manual completely.

Page 1~20

#### 使用說明書

請詳細閱讀這本使用說明書以了解正確的使用法，使機器長久發揮最高性能。

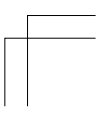
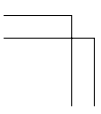
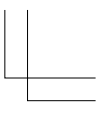
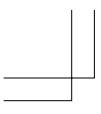

21~40頁











# 安全上應特別注意之事項





- 使用前，請詳細閱讀「安全上的注意事項」，以正確的使用機體。
- 在所示注意事項的“⚠ 警告”、“⚠ 注意”需特別加以注意。“警告”欄中記載之事項，表示處理錯誤時，可能會造成死亡或重傷，而“注意”欄中記載之事項，因狀況也可能造成重大之後果，所以請務必遵守，以維護安全。
- 標記事項如下。

 確定地線已連接。	 圖象中的這標記表示禁止事項。
 圖象中的這標記表示必須遵守事項。	

- 閱讀完後，請務必妥善保管。

安裝上的注意事項	
 警告	<ul style="list-style-type: none"> <li>● 請勿重組機件。 自己重組機件可能會造成漏水、故障、觸電及火災。</li> </ul> 
	<ul style="list-style-type: none"> <li>● 安裝時，請委託經銷商或專門技術人員安裝。 自己安裝可能會造成漏水、觸電及火災。</li> </ul>
 注意	<ul style="list-style-type: none"> <li>● 請使用接地線。 地線請勿安裝在瓦斯管、水管、避雷針、電話之地線等場所。</li> </ul> 
	<ul style="list-style-type: none"> <li>● 依設置場所狀況，有必要安裝漏電斷電器。 如沒有安裝漏電斷電器時，會有觸電的危險。</li> <li>● 不可安裝於有可燃氣體的場所，因為萬一氣體洩漏在機體周圍的話，可能會發生火災。</li> <li>● 安裝排水管時，請確認水可否順利的流出。</li> </ul> 

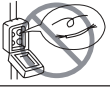
搬移或修理時的注意事項	
 警告	<ul style="list-style-type: none"> <li>● 異常時（有焦味等），請停止運轉後把斷電器關閉，並通知經銷服務人員。有異常而照舊連續運轉的話，會造成故障、觸電、火災等。</li> </ul> 
	<ul style="list-style-type: none"> <li>● 維修時，請直接向經銷服務人員接洽。 自己修理不完全的話，會有觸電、火災的危險。</li> </ul>
	<ul style="list-style-type: none"> <li>● 機體要移動重新再設置時，請直接向經銷服務人員接洽。 自己移動機體，重新再設置時，若安裝不安全的話，就會有觸電、火災的危險。</li> </ul>
	<ul style="list-style-type: none"> <li>● 如果電線有任何損壞，請從合資格的服務或零件中心購買適用的更換電線。</li> </ul>

使用上的注意事項	
 警告	<ul style="list-style-type: none"> <li>● 身體請勿長時間直接對著冷氣，以免妨礙健康。</li> </ul> 
	<ul style="list-style-type: none"> <li>● 請勿將細棒等物品插入吹出口及吸入口，由於風扇在高速運轉，易造成危險。</li> </ul> 
	<ul style="list-style-type: none"> <li>● 請勿以金屬或銅線當作保險絲，以免發生故障或火災。</li> </ul> 
	<ul style="list-style-type: none"> <li>● 有打雷之可能時，為了保護機械，請停止運轉，並把斷電器關閉，以避故障發生。</li> </ul> 

## 使用上的注意事項

- 本機請使用在以一般家庭的人為對象的場所，請勿使用在保存食品、動植物、精密機器、美術品、醫藥品等特殊場所。



- 請不要用濕手來操作開關，以免觸電。

- 與燃燒器具一起運轉時，請常換氣，否則會有氧氣不足的情形。



- 本機所吹出來的風，請不要直接吹在燃燒器具上，否則，會使燃燒器具燃燒不完全。

- 長期使用的安裝材料請隨時注意其是否穩固，不可有損傷的情形。否則機體可能會落下造成危險。



- 清洗機體時，請絕對避免用水潑機體，因會有漏電的危險。

- 請勿在室內機旁噴灑煙霧或美髮劑。化學物會粘附在散熱片及堵塞蒸發水流向盛水盤。水將會滴在切線形風扇飛濺而出。



警告

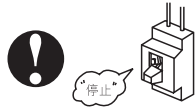

- 清潔機體時，請停止運轉並把斷電器關閉。因為機體內部的風扇正以高速運轉，會造成傷害。

- 長時間不運轉時，為了安全起見，請把斷電器關閉。



- 請勿爬上機體，物品也不要放在機體上面。

- 機體上請不要放有水的容器（如花瓶），以免傾倒流入機體內部，會使機體內部電氣絕緣劣化，產生觸電的危險。



- 動植物請不要放置在風向直接吹到的場所，否則會對動植物有不良的影響。

- 冷氣運轉時，窗和門在開放的狀態下（室內濕度必須在80%以上），風向板向下時，都請不要長時間運轉，否則上下風向板會結露，有時會滴下來，而使傢俱弄濕。

- 房間如果有超過冷氣能力的熱源（如房間有多人進入，使用熱器具等），將無法達到所設定室溫。

- 不要讓小孩單獨操作使用機器。除非在監督責任人的指導下，確保他們能安全正確的使用機器。

- 請確保小孩遠離機體，不要機體玩耍，以免發生危險。



# 各部的名稱和功能

## 室內機

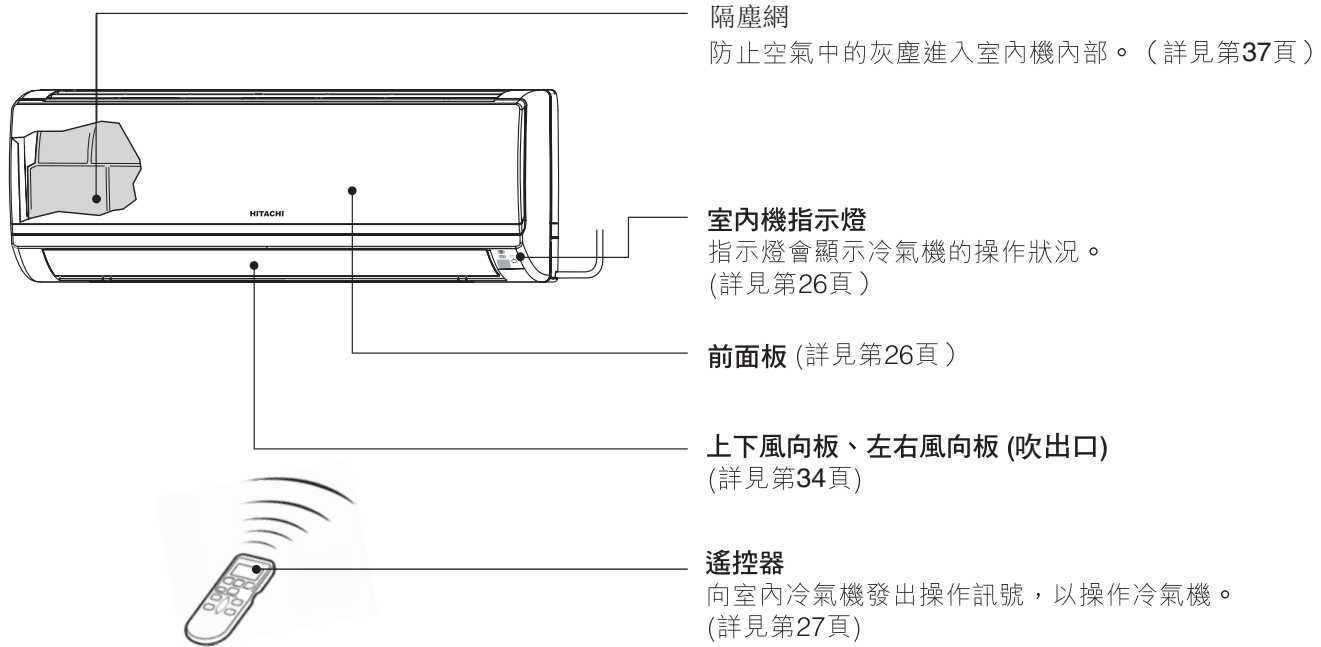

## 室外機

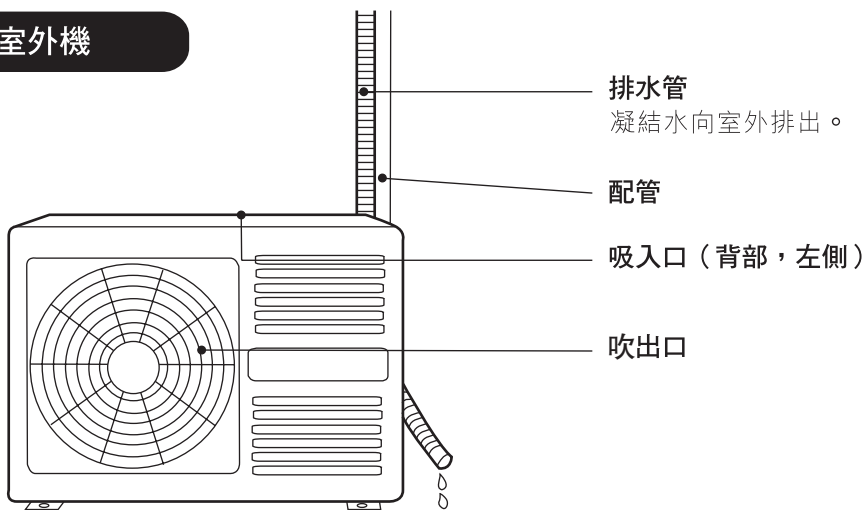

## 型號及外型尺寸

型號	寬 (mm)	高 (mm)	深 (mm)
RAS-X10CCK, RAS-X13CCK、RAS-X18CCK	780	280	218
RAC-X10CCK、RAC-X13CCK	700 (+59)	505	258 (+48)
RAC-X18CCK	750 (+91)	548	288 (+47)

## 裝置及卸下前面板

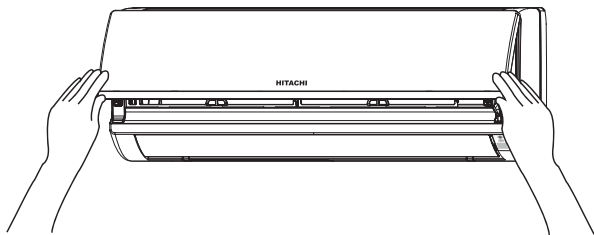

- 雙手握住冷氣機前面板（位於冷氣機的正前方）的兩側，拉起以打開前面板。
- 完成工作後，輕輕拉起面板，然後向下拉合上前面板，檢查左右及中間位置是否已完全合上。

## 接收指示功能

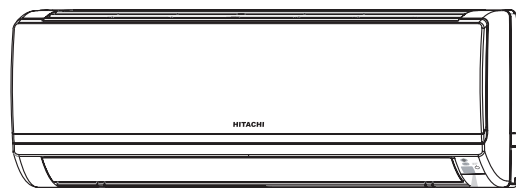

### ▲ 提示

如長時間不使用冷氣機，請切斷電源或拔下插頭。

#### 定時指示燈（橙）

機體做預約定時時，此指示燈會亮。

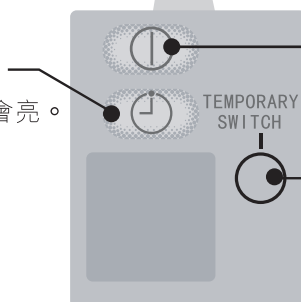

#### 運轉指示燈（黃）

機體保持運轉狀態時，此指示燈會亮。

#### 應急開關

## 操作指示

### 應急開關

無法使用遙控器時，請使用應急開關模式。

- (1) 按下應急開關時，機器以前次所設定的模式開動。如斷開電源后再開動時，機器就以自動模式運轉。
- (2) 第二次按應急開關，以停止冷氣機操作。

### 自動重開功能

電力故障後，冷氣機將自動重開。

※（電力故障發生時，如遙控器設定為定時器狀態，冷氣機將不會自動重啟。）

## 遙控器各部分名稱和功能

### 遙控器

此遙控器用以控制室內機的運轉。控制範圍大約為7米，如果用電子方法控制室內照明的話，控制範圍可能變小，特殊情況，可能導致遙控器信號無法到達。

此機器使用提供的安裝板固定在牆壁上，請在固定它之前，務必確認可以使用遙控器控制室內機。請小心操作遙控器。避免跌落或者受潮。

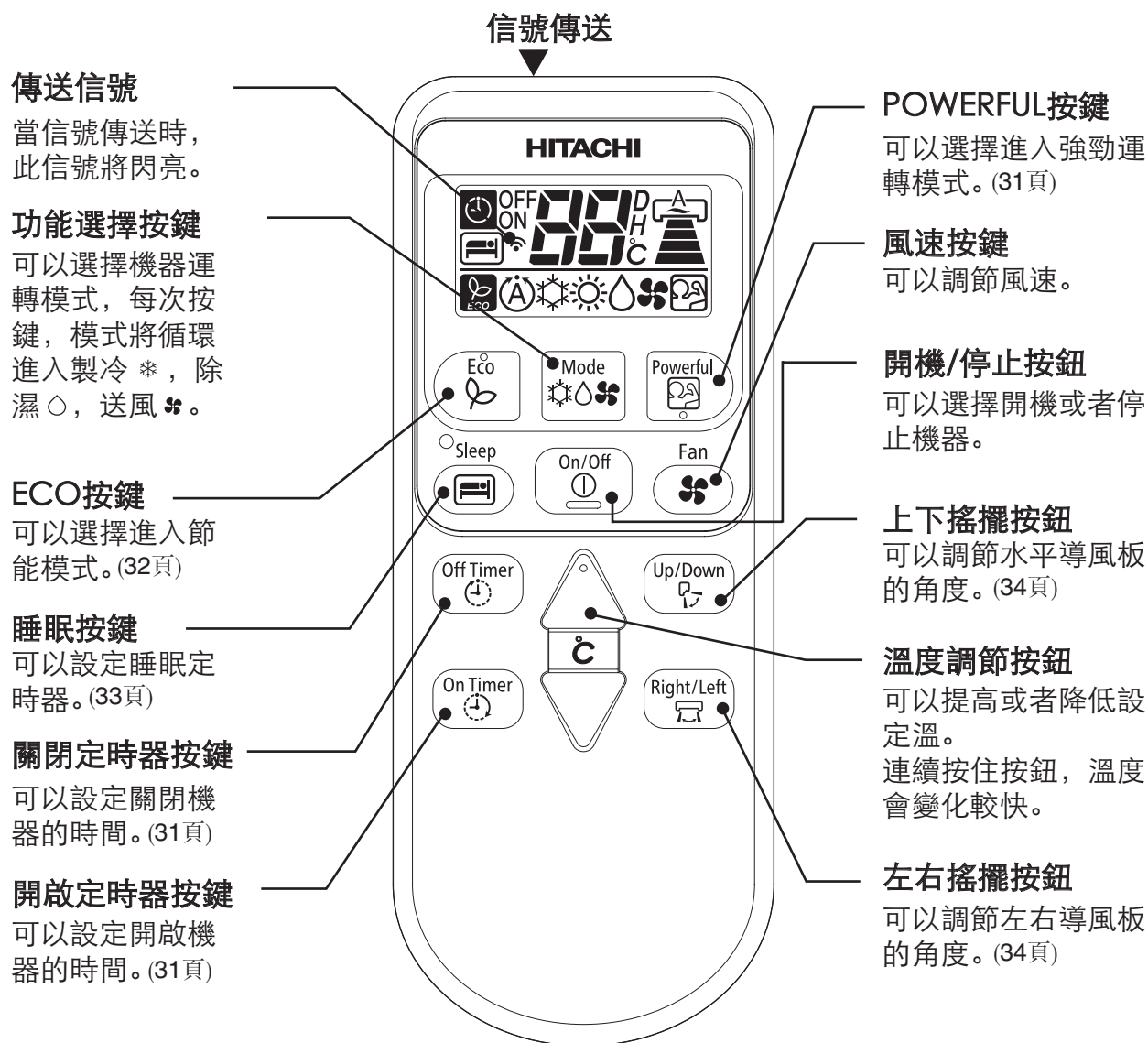

### 使用時應注意事項

- 遙控器不可放在下述地方
  - 直射的陽光下
  - 加熱器附近
- 遙控器小心使用，不可跌落與地板，并避免受潮。
- 一旦室外機停止，它將停止大約3分鐘。(除非將電源開關關閉打開，或者將電源插頭拔掉再插入。)  
這是為了保護機器，且沒有故障提示。
- 如果通過功能選擇鍵調整運轉模式，同樣可能為了保護機器，停止運轉約3分鐘。

## 製冷運轉

當屋外溫度在攝氏 -10度至43度的範圍內時可用本機進行製冷運轉。如室內濕度很高（80%以上）時，室內機放氣口格柵上會結露。

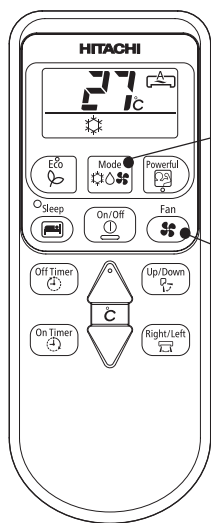

1

按壓功能選擇按鈕后顯示 ❄️（製冷）。

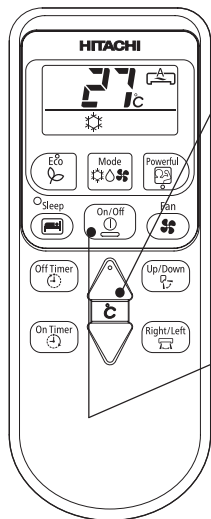

2

用 ❄️（風速）鈕設定所希望的風扇速度（顯示器指示設定速度）。

- ❄️（自動）：風扇速度起先是（高），然後達到了預設溫度時自動改變為（中）或（低）或（寧靜）。
- ↓
- ❄️（高）：風速強勁
- ❄️（中）：風速平穩
- ❄️（低）：較安靜
- ❄️（寧靜）：非常安靜

3

用溫度調節鈕設定所希望的室溫（顯示器指示設定溫度）。在不同條件下，設定溫度與室溫有少許差異。

開始  
停止

按壓 ①（開始/停止）按鈕，發出提示音后製冷運轉開始。再次按壓這個按鈕將停止運轉，另設定溫度高於當前室溫冷氣機也不啟動（運轉指示燈始終點亮）。製冷運轉需要將設定溫度盡可能設定低於當前房間溫度。

■ 設定將保存在遙控器內存中，下次可以直接按壓 ①（開始/停止）按鈕。

## 除濕動作

室溫高於攝氏16度時可用本機進行除濕工作。  
當室溫低於攝氏15度時除濕功能不能起動。

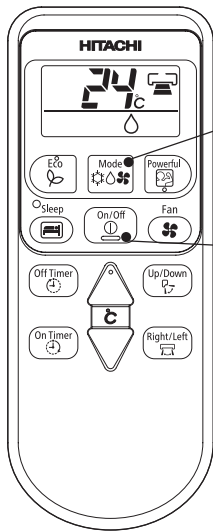

1

按壓功能選擇鍵，遙控器液晶將顯示 ◯（除濕）。  
按壓 風速（風速）按鈕選擇低速或者寧靜。

開始  
停止

按壓 ①（開始/停止）按鈕。

- 需要設定運轉模式時，請使用功能選擇鍵。
- 選擇適宜的溫度。

### ■ 除濕機能

除濕功能的目標溫度將略低於設定的室溫。

室溫低於設定溫度時；將室溫設定於低於實際的室溫時（無論設定溫度如何），機器就進行除濕工作。  
當室溫低到設定溫度以下時，除濕工作就立刻停止（室內機停止發出空氣）。

## 送風運轉

可以使用此功能進行空氣循環，也可以在夏季結束後使用此功能乾燥室內機內部。

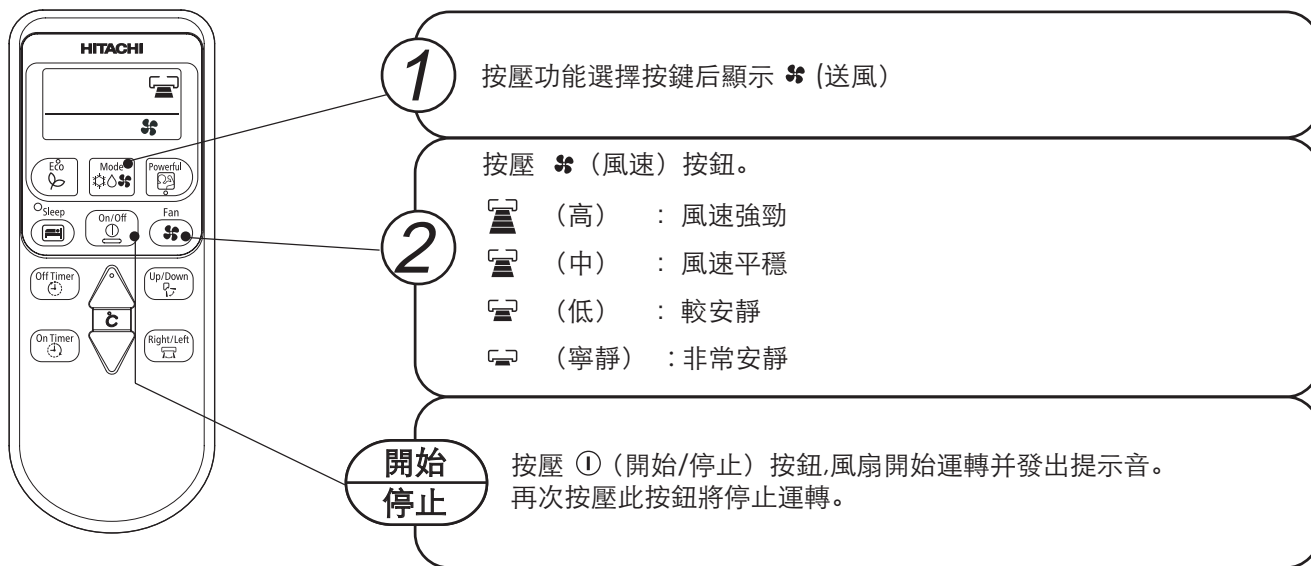

### 風扇速度 (自動)

製冷運轉時風扇速度設定為自動

製冷運轉時

- 運轉開始，將以高風速使房間溫度達到與設定的溫度
- 房間溫度到達與設定溫度后，風扇將自動調整為低風速

## 定時器的設定法

■ 可開啟及關閉定時器。

### 預留時間

#### 1 設定關閉時間

- 按  (關閉) 鈕關閉時間。
- 按照下列程序選按鈕，可更改設定時間。



#### 2 設定開啟時間

- 按  (開啟) 鈕開啟時間。
- 按照下列程序選按鈕，可更改設定時間。

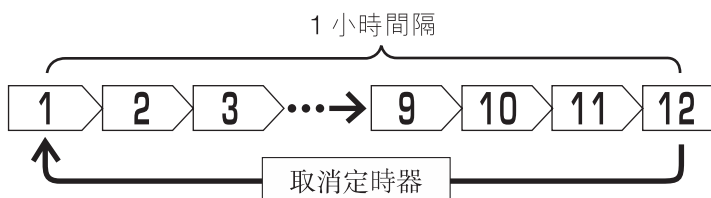

■ 於設定時間停止運作

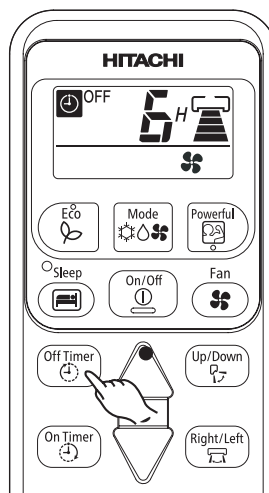

■ 於設定時間，開始運作設定的溫度 (開始時間會因室溫及設定溫度而有所不同)。

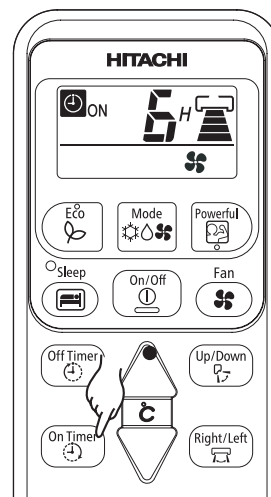



## 強勁運轉

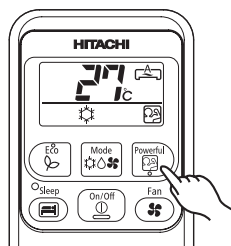

- 按壓  (強勁) 按鈕將調整除濕，製冷，送風運轉至最大功率。
- 在強勁運轉時，室內機吹出的空氣將較冷。



### 運轉

- 按壓  (強勁) 按鍵在運轉時
- "  " 將顯示在遙控器液晶上。

### 停止

- 按壓  (開始/停止) 按鈕。
- 或者再次按壓  (強勁) 按鈕。
- "  " 將從遙控器液晶上消失。

### 注意

- 選擇節能模式后，強勁運轉將被取消。
- 在強勁運轉時，冷氣機的能力將不會增加  
-如果冷氣機已經運轉在最大功率輸出狀態。
- 自動重啟之後，強勁運轉將被取消，以之前的設定開始運轉。

## 節能運轉

- 節能運轉是通過改變設定溫度和限制最大功率以實現。

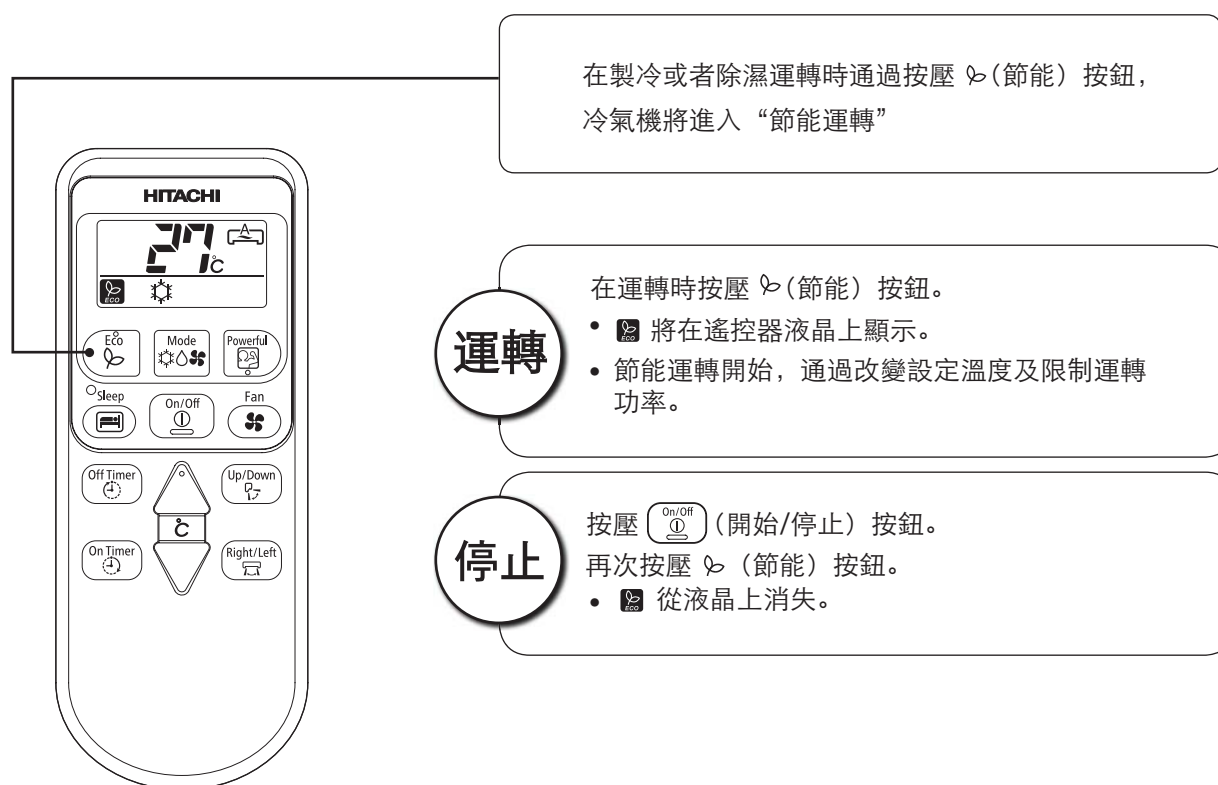

### 注意事項

- 如果功率消耗已經是很小時，節能功能不再降低功率消耗。
- 開啟（強勁）功能后，節能運轉將取消。
- 自動重啟之後，節能運轉將被取消，以之前的設定進行運轉。



## 睡眠定時器的使用方法

在製冷，除濕，送風運轉時按壓  (睡眠) 按鈕，冷氣機將調整房間溫度和重設風扇轉速。

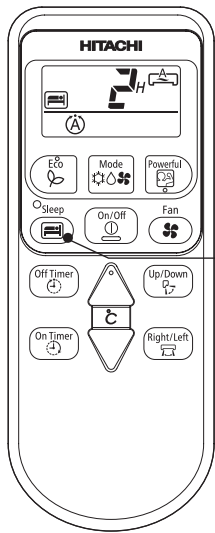



● 睡眠

模式	指令
睡眠定時器	1小時 → 2小時 → 3小時 ... → 12小時 定時器關閉 ←

**睡眠定時器：**冷氣機將在設定時間到達后停止運轉  
定時器信息將顯示在遙控器液晶上，室內機定時燈也將點亮并有提示音。

### 取消睡眠運轉

按壓  (開始/停止) 按鈕

- 冷氣機將停止運轉。  
一直按壓  (睡眠) 按鈕直到定時器關閉， 和小時數字在遙控器液晶上消失。
- 室內機發出提示音並且室內機定時燈關閉。
- 睡眠定時器被取消。

### 注意

如果開啟定時器或者關閉定時器已經設定，睡眠定時器設定時將代替開啟或關閉定時器的設定。

## 風向板的調節方法

### 1 風向板的上下方向調整

水平導風板在各種運轉狀態時被自動設定在合適的角度，導風板可以使用  (上下搖擺) 按鍵調整上下擺動或者需要的角度。

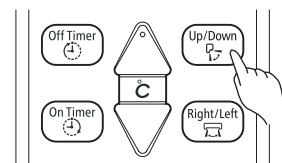

- 如果按壓  (上下搖擺) 按鈕一次，水平導風板將上下擺動，如再次按壓這個按鈕，導風板將停止在當前位置。
- 水平導風板的調整角度可以參照右圖。
- 運轉停止的時候，水平導風板將搖擺至出風口關閉的位置。

#### 警告

- 製冷運轉時，不要長時間搖擺水平導風板，可能造成導風板結露。

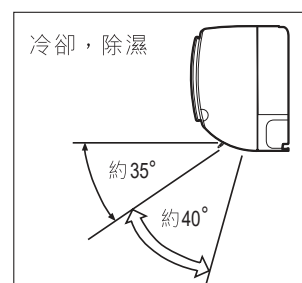

### 2 風向板的左右方向調整

- 如果按壓  (左右搖擺) 按鈕一次，左右導風板將左右擺動，如再次按壓這個按鈕，導風板將停止在當前位置。

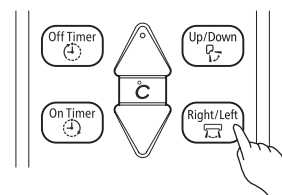

## 遙控器中電池的更換法

- 1 取下電池盒蓋如圖所示，然後取出舊電池。



- 2 將新電池裝進去。  
請注意電池極性方向應和盒內所示標記一致。

#### 注意

1. 新電池和舊電池，或不同種類的電池不可混用。
2. 兩個月或三個月不使用遙控開關時最好把電池取出。
3. 使用高質素及高效能的AAA電池，可延長操作時間，避免電解質外流。

更換遙控器內的電池

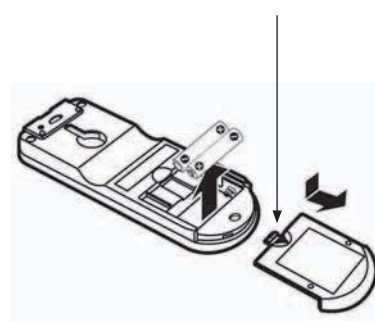



## 最佳的使用方法

### 室溫設定要適當



#### 警告

過冷對健康不好且會浪費電力。

### 裝置窗簾或百葉窗

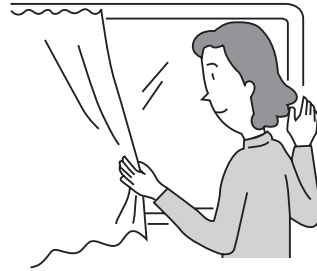

可隔絕從窗戶進來的熱源。

### 換氣

#### 注意

房間不要關閉太久，請偶爾打開窗戶，換新鮮空氣。



### 時間預校的有效活用

晚上用“開關時間預校”再配合早上的睡醒時間，可得到舒適的溫度，請有效活用時間預校。

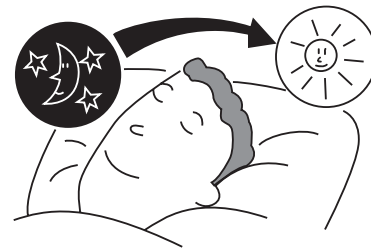

### 濾網請不要忘記清洗

濾網的網目塞住會影響風量，減弱冷氣效果，為了不浪費電力，請每隔 2 週務必清洗一次。

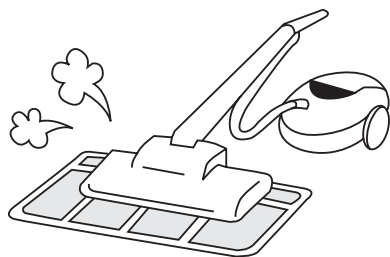

### 為了嬰兒及小孩，請注意 室溫調節

行動不便的嬰兒、小孩、老年人等使用冷氣機時，請注意室內溫度及風向的調節。  
(最佳的室內和室外溫差為攝氏±5度。)





## 顧客須知

### 冷氣機和房間的熱源

#### 注意

房間如果有超過冷氣能力的熱源（如房間有多人進入，使用熱器具等），將無法達到所設定的室溫。

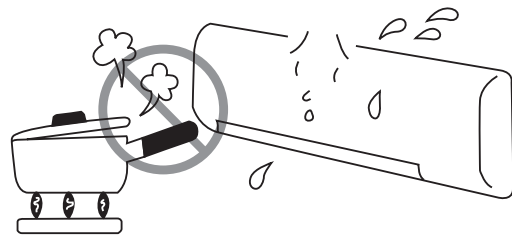

### 長時間不使用時

機器長時間不使用時，請將電源插頭拔起。否則，雖然不運行，亦會消耗掉使用於控制回路的電力（約1W）。

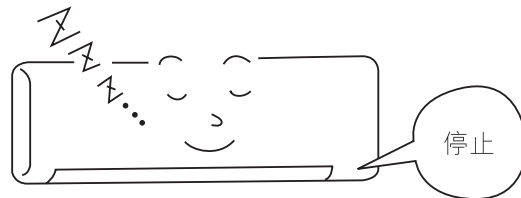

### 有閃電之虞時

#### 警告

有閃電之虞時，為了保護機械而需停止運轉，請把電源插頭拔起。

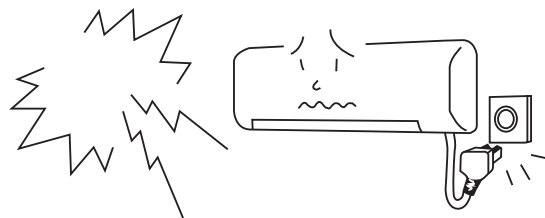

### 其他電器的干擾

#### 注意

請將室內機及遙控器安裝在距離其他電器至少1米以  
避免雜聲的干擾。

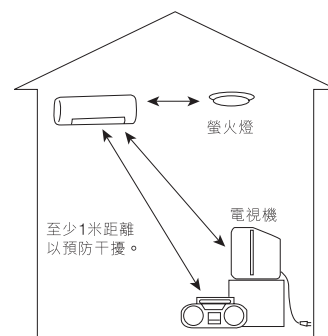

## 機器的保養

### ⚠ 注意

清潔冷氣機前，請關閉冷氣機並拔掉電源插頭。

### 隔塵網

隔塵網可過濾外來的塵埃粒子，所以應時常保持清潔。冷氣機操作約 100 小時後，便應清潔隔塵網。隔塵網上過量的灰塵，將阻礙空氣的流動，減低冷氣效能，冷氣機甚至會發出噪音。因此應清潔隔塵網，清潔說明如下：

### 清潔說明

#### (1) 移除隔塵網。

- 雙手握著前面板的兩邊，拉開並揭起前面板，然後推上以固定前面板。

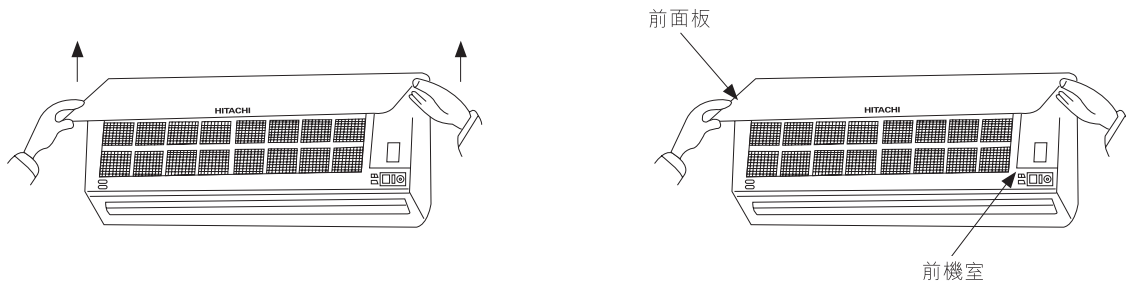

- 輕輕拉起隔塵網，鬆開於前機室下方的兩個門夾，以拉出隔塵網。

(2) 用吸塵機清潔隔塵網積聚的灰塵。如果無法用吸塵機完全清除積聚的灰塵，可使用中性的清潔劑，並用清水沖洗隔塵網。清洗後，請將隔塵網置於陰涼處風乾。

(3) 最後，把隔塵網裝回原處（標有“FRONT”的那一面）。輕輕拉開前面板，並於原來位置合上面板。

(4) 每年也應清潔蒸發器，在使用冷氣機前，可用軟毛刷子或吸塵機清潔蒸發器，但請小心，避免損壞蒸發器。

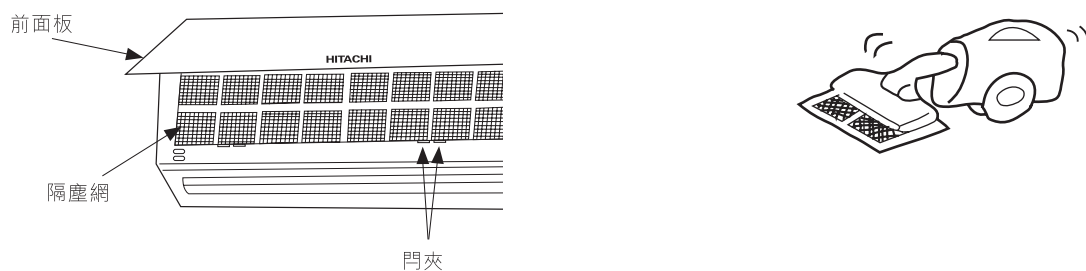

### ⚠ 注意

- 請勿使用超過 40°C 的熱水沖洗隔塵網，否則隔塵網會彎曲變形。沖洗後，搖動隔塵網，清除多餘的水分，然後將隔塵網置於陰涼處風乾。避免陽光直接照射隔塵網，否則隔塵網會彎曲變形。開啟冷氣機前，請安裝隔塵網，否則吸入的塵埃可能會損壞冷氣機。

## 清潔前面板

1. 前面板容易積聚污垢，可用軟布清潔。
2. 如果前面板非常骯髒，可用沾有溫水或中性清潔劑的濕布拭抹，然後再用乾布抹乾前面板。
3. 請勿使用超過 50°C 的熱水、揮發性液體、汽油、酸性液體、稀釋液或刷子清潔前面板，否則會損壞前面板的塑膠光油與漆面。

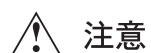

### 注意

清潔前面板前，請拔掉電源插頭。

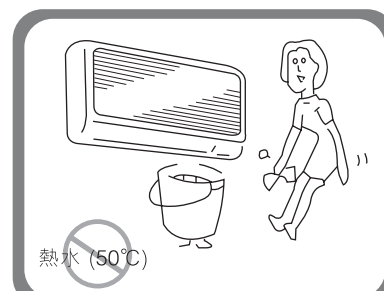

## 聯絡服務人員前請檢查下列各項目

冷氣機不能操作。

- 檢查電源插頭是否已正確插好。

冷氣機出現不正常反應。

1. 隔塵網是否積滿灰塵及污垢？
2. 陽光是否直射在室外機上？
3. 室內或室外機的空氣流動是否受阻？
4. 房門或窗口是否開著或是否室內有其他熱源？
5. 設定溫度是否適當？

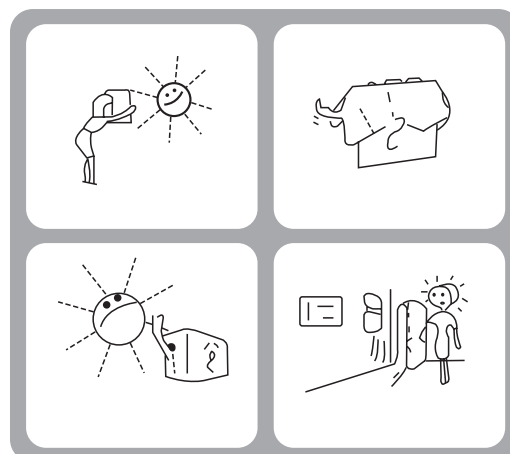



## 售後服務和保證事項

請服務人員檢修以前，請先依下列各項檢查

狀況	請檢查以下幾點
<p>不能運轉時</p>	<ul style="list-style-type: none"> <li>● 保險絲是否熔斷？</li> <li>● 電壓是否過高或過低？</li> <li>● 電源開關是否設在“ON”的位置？</li> </ul>
<p>冷氣不冷時</p>	<ul style="list-style-type: none"> <li>● 濾塵網是否太髒？</li> <li>● 陽光是否直射在室外機上？</li> <li>● 室外機的空氣流通是否受阻？</li> <li>● 房門或窗口是否開著或是否室內有其他熱源？</li> <li>● 設定溫度是否適當？</li> </ul>



### 注：

- 在較低風速運轉時，或當停止運轉時，有時會發生下述現象。但這些都不是不正常的現象。
  - (1) 冷卻動作中會聽見冷凍劑流動的微小聲音。
  - (2) 風扇罩受熱或受冷時所發出的微小摩擦聲。
- 冷氣機有時會發出異味，但這並非不正常的現象，而是因為煙，食物，化妝品等所發出的異味附著在上面的緣故。所以最好經常清理濾塵網和蒸發器部份以減少異味。

- 上述各項檢查調整後，冷氣機仍舊不能正常運轉的話，請立刻通知購買的經銷商，並請將保證書上所記載的冷氣機形式，製造號碼，安裝日期及冷氣機故障狀況告訴經銷商。
- 電源軟線應連接在適當的定額電壓，否則機器將會損壞或不能達到預定的效能。

